

气体放电管
Gas Discharge Tube (GDT)



特征 Features

- 快速响应
- 性能稳定
- 高通流
- 低电容
- 高绝缘
- 符合RoHS & REACH要求

Fast Response

Stable Performance Over Surface Life

High Current Rating

Low Capacitance

High Insulation Resistance



RoHS & REACH Compliant

气体放电管特性与型号概览

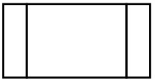
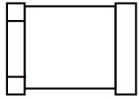
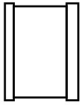
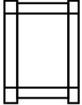
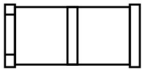
Gas Discharge Tube (GDT) Features & Model List Overview

直流击穿电压 DC Spark-over Voltage (V)	12	13	14	15	16	18	17	19	20	页码 Page		
	2000	○	○	○	○	○	○	○	○	○	型号 Model	
1500	○	○	○	○	SD	SM	○	○	○			
1200	○	○	○	○	SD	○	SS	○	○			
1000	○	○	○	○	SD	SM	SS	○	○			
800	○	○	○	SN	SD	SM	SS	○	○			
600	○	SW	SX	SN	SD	SM	SS	SC	TZ			
470	○	○	○	○	○	SM	SS	○	TZ			
420	SZ	SW	SX	SN	SD	SM	SS	SC	TZ			
350	○	○	○	SN	SD	SM	SS	○	TZ			
300	SZ	SW	SX	SN	○	○	SS	SC	○			
250	○	○	○	○	○	SM	SS	○	○			
230	○	SW	SX	SN	SD	SM	SS	SC	TZ			
200	SZ	SW	SX	SN	SD	SM	SS	SC	TZ			
150	SZ	SW	SX	SN	SD	SM	SS	SC	TZ			
90	SZ	SW	SX	SN	SD	SM	SS	SC	TZ			
75	○	○	○	SN	SD	○	SS	○	TZ			
70	○	○	○	SN	○	SM	○	○	○			
尺寸 Size (mm)	1.6 × 1.6 × 3.2	3.2 × 2.5 × 2.5	4.5 × 3.2 × 2.7	5 × 5 × 4.2	Φ5 × 5	Φ9.3 × 6	6.2 × 6.2 × 4.2	8.3 × 8.3 × 6	Φ5 × 7.6			
冲击放电电流 Impulse Discharge Current (kA)	0.5	1	1 / 2	5	5	20	5	20	5 / 10			
产品结构 Product Structure	 <p>贴片结构 (全方) SMD Shape (Square)</p>				 <p>贴片结构 (一端是正方形, 另一端是圆形) SMD Shape (One end is square and the other is round)</p>		 <p>贴片结构 (两端为正方形, 中间圆形) SMD Shape (Middle circle and square at both ends)</p>		 <p>贴片形状 (八边形) SMD Shape (Octagon)</p>		 <p>贴片结构 (一端是正方形, 另一端和中间是圆形) SMD Shape (One end is square and the other is round)</p>	

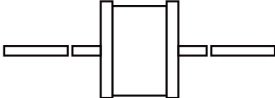
气体放电管特性与型号概览
Gas Discharge Tube (GDT) Features & Model List Overview

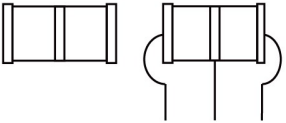
	21	22	25	26	28	30	31	23	24	页码 Page
3600	SF	SE	○	○	○	○	○	○	○	型号 Model
3000	SF	SE	○	○	○	○	○	○	○	
2500	SF	SE	○	○	○	○	SPI	○	○	
2000	○	○	SPA	○	○	○	○	○	○	
1500	SF	SE	SPA	SPB	SPC	SPJ	SPI	○	○	
1400	○	○	○	○	○	○	○	○	○	
1000	○	○	○	SPB	SPC	SPJ	SPI	○	○	
800	SF	SE	SPA	SPB	SPC	SPJ	SPI	○	○	
600	SF	SE	SPA	SPB	SPC	SPJ	SPI	TB	TR	
470	SF	SE	SPA	○	○	○	○	TB	TR	
420	○	○	○	○	○	○	○	TB	TR	
350	SF	SE	SPA	SPB	SPC	SPJ	SPI	TB	TR	
300	○	○	○	○	○	○	○	○	○	
250	○	○	○	○	○	SPJ	○	○	○	
230	SF	SE	○	○	SPC	SPJ	○	TB	TR	
200	○	○	○	○	○	○	○	○	○	
150	SF	SE	○	○	SPC	○	○	TB	TR	
90	SF	SE	○	SPB	SPC	○	○	TB	TR	
75	○	○	○	○	○	○	○	○	○	
70	○	○	○	○	○	○	○	○	○	
尺寸 Size (mm)	Φ5.5 × 6	Φ8 × 6	Φ11.8 × 16	Φ11.8 × 6.2	Φ11.8 × 4.2	Φ16 × 4.5	Φ16 × 8	Φ6 × 8.5	Φ8 × 10	
冲击放电电流 Impulse Discharge Current (kA)	3 / 5 / 10	5 / 10 / 20	30		20		40	5 / 10	5 / 10 / 20	
产品结构 Product Structure	 <p>轴向形状 Axial Shape</p>						 <p>径向形状 Radial Shape</p>			

气体放电管

Gas Discharge Tube (GDT)

产品描述 Description

气体放电管是一种在金属电极和金属化陶瓷的空间里，充入一定比例的惰性气体或其它混合气体等放电介质，经过高温封接而成单间隙或多间隙的开关型防护器件。当被保护的电路或设备受到浪涌冲击时，放电管将从高阻抗状态变为低阻抗状态并释放浪涌能量，降低电路残压，进而保护设备或人身免受瞬态过电压的危害。赛尔特公司的气体放电管产品电压70 ~ 4500 V，通流 (@8/20 μs) 0.5 ~ 200 kA全系列覆盖，被广泛应用在信号、电源及各类端口的过压防护；安规认证包括：UL、cUL、TUV，同时满足RoHS、REACH要求。

The Gas Discharge Tube (GDT) is a protective device which is filled with certain proportion of noble gas, or mixed gas or other discharge media in the space between metal electrodes and metalized ceramics, and then sealed at high temperature to form a single-gap or multi-gap switch type protective device. When the protected circuit or equipment suffers to surge, GDT will change from high impedance state to low impedance state and release the surge energy to reduce the residual voltage of the circuit, and then protect the equipment or humanbody from the hazard of transient overvoltage. SETsafe | SETfuse GDT product the voltage range 70 to 4500 V, and surge current (@8/20 μs) range 0.5 to 200 kA. It is widely used in the overvoltage protection of signals, power supplies and various ports; safety regulations Certificates include UL, cUL, TUV, and it meets for RoHS & REACH requirements.

应用 Applications

- 宽带 WLAN xDSL
- 有线电视 CATV
- 配线架 MDF
- 数据端口 Ethernet
- 基站 BTS (Base Station)
- 天线 Antenna and RF
- 电源 Power Supply
- 消费类电子 Consumer Electronics
- 交流电源的N-PE保护 N-PE Protection in AC Power

结构图 Structure

二极管气体放电管 2-Electrode Gas Discharge Tube

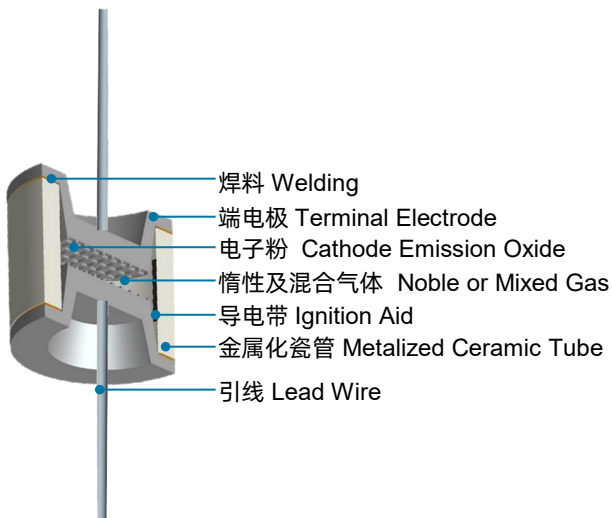

三极管气体放电管 3-Electrode Gas Discharge Tube

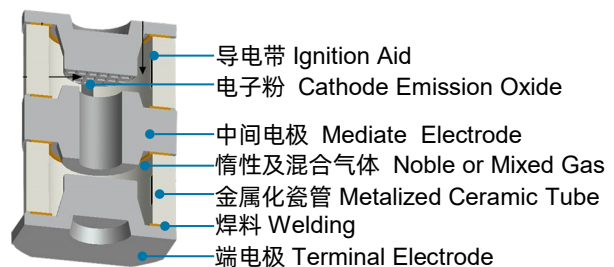

气体放电管

Gas Discharge Tube (GDT)

编码系统 Part Numbering System



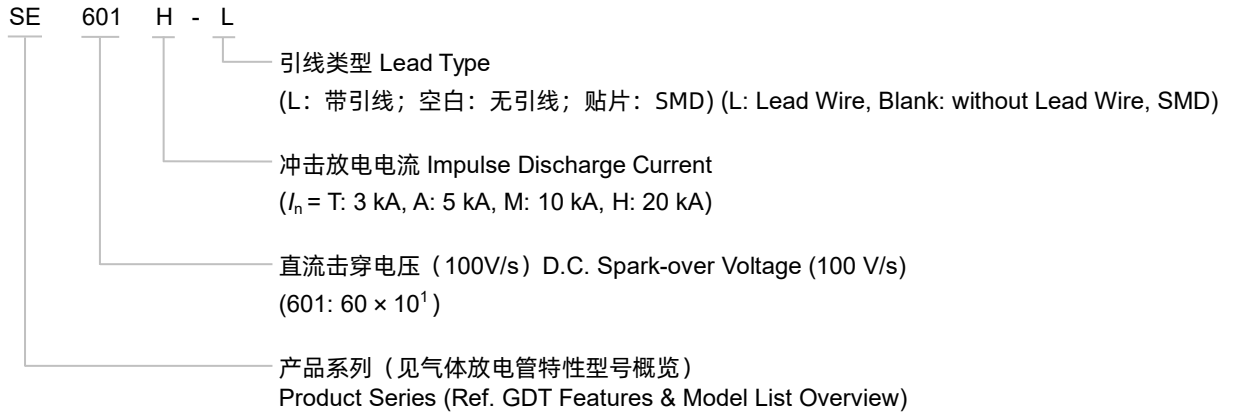

中小通流 Small and Medium Surge GDT

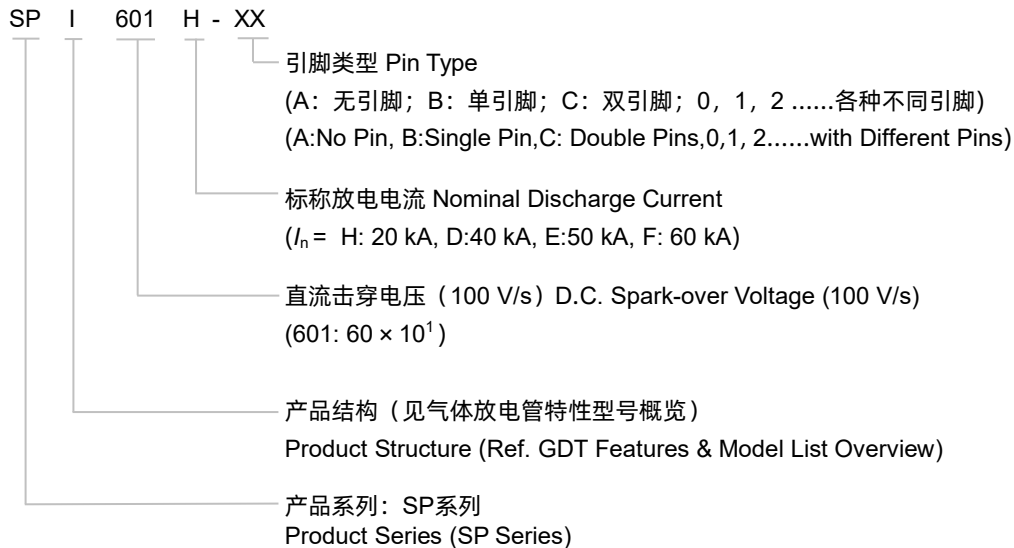

大通流 Heavy Surge GDT



安规认证 Agency Approvals

认证标志 Agency Mark	标准 Standards	认证号 File No.	类别 Category
	UL 497B	E513446	QGVQ2
	UL1449	E322662	VZCA2
	EN 61643-311	No.B107221001 Rev.00	N/A
	EN 61643-311	No.B107221002 Rev.00	N/A
	EN 61643-311	On-going	N/A

气体放电管

Gas Discharge Tube (GDT)

术语 Glossary

项目 Item	描述 Description
V_s	<p>直流击穿电压 D.C. Spark-over Voltage 气体放电管两端施加一个缓慢上升使其击穿的直流电压。 The voltage at which the GDT sparks over with slowly increasing d.c. voltage. — (IEC 61643-311)</p>
V	<p>冲击击穿电压 Impulse Spark-over Voltage 从施加给定波形的冲击起直至开始有电流流通的这段时间内，气体放电管两端子上出现的最高电压。 The highest voltage which appears across the terminals of a GDT in the period between the application of an impulse of given wave-shape and the time when current begins to flow. — (ITU-T K.12)</p>
V_a	<p>弧光电压 Arc Voltage 弧光电流流过气体放电管时的电压降。 Voltage drop across the GDT during arc current flow. — (IEC 61643-311)</p>
V_{gl}	<p>辉光电压 Glow Voltage 辉光电流流经期间，跨越气体放电管的电压降的峰值，它有时也被称为辉光模式电压。 The peak value of the voltage drop across the GDT when a glow-current is flowing, It is sometimes called the glow mode voltage. — (ITU-T K.12)</p>
$8/20 \mu s$	<p>8/20冲击电流 8/20Current Impulse 一个上升时间为8 μs，半峰值时间为20 μs的冲击电流波形。 Current impulse with a nominal virtual front time of 8 μs and a nominal time to half-value of 20 μs. — (IEC 61643-11)</p>
$1.2/50 \mu s$	<p>1.2/50 冲击电压 1.2/50 Voltage Impulse 一个上升时间为1.2 μs，半峰值时间为50 μs的冲击电压波形。 Voltage impulse with a nominal virtual front time of 1.2 μs and a nominal time to half-value of 50 μs. — (IEC 61643-11)</p>
I	<p>交流放电电流 Alternating Discharge Current 流经气体放电管的近似正弦交流电流的有效值。 The r.m.s. value of an approximately sinusoidal alternating current passing through the GDT. — (ITU-T K.12)</p>
I_n	<p>标称放电电流 Nominal Discharge Current 允许通过气体放电管波形为8/20 μs冲击电流值。 Crest value of the current through the GDT having a current waveshape of 8/20 μs. — (IEC 61643-11)</p>
I_{max}	<p>最大放电电流 Maximum Discharge Current 允许通过气体放电管波形为8/20 μs冲击电流最大值，该参数由制造厂商自行规定，一般I_{max}大于I_n。 Crest value of a current through the GDT having an 8/20 μs waveshape and magnitude according to the manufacturers specification. I_{max} is equal to or greater than I_n. — (IEC 61643-11)</p>

GDT

GDT

气体放电管

Gas Discharge Tube (GDT)

击穿电压参考曲线 (参照230 VDC)

Reference Curve for Spark-over Voltage (Refer to 230 VDC)

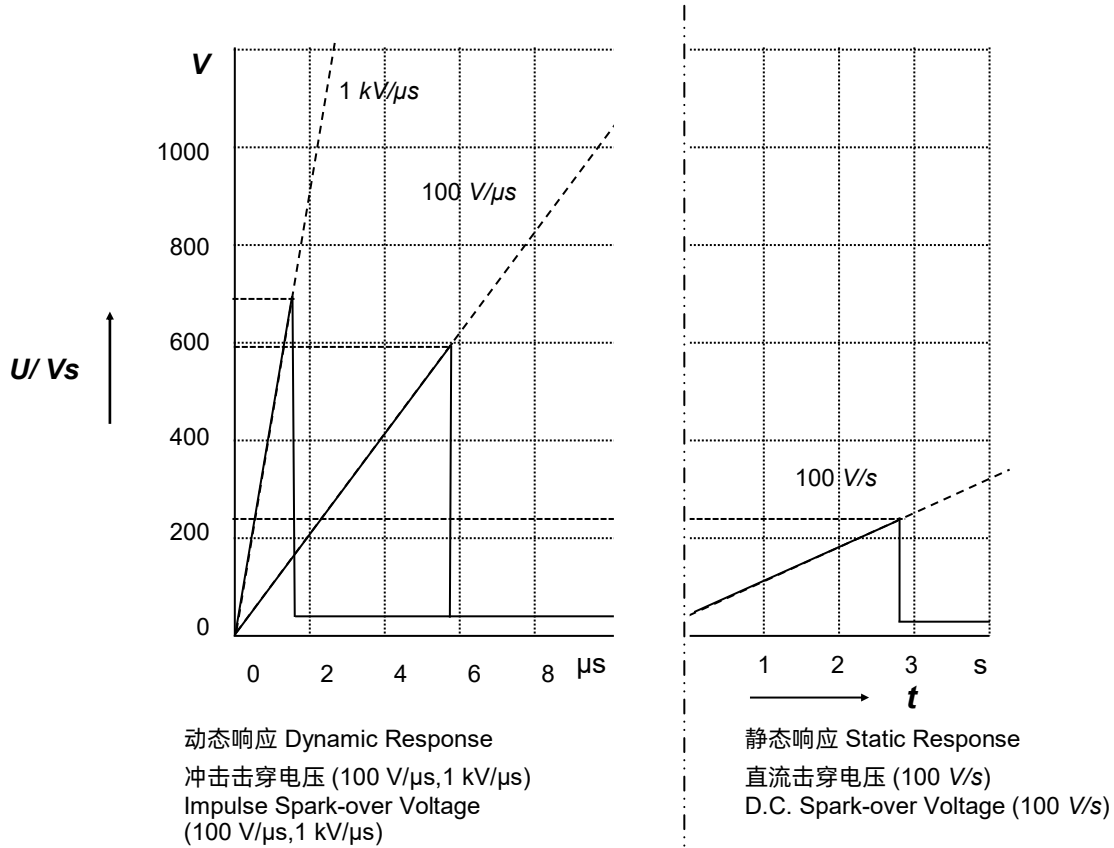

冲击电流的参考曲线

Reference Curve for Impulse Discharge Current

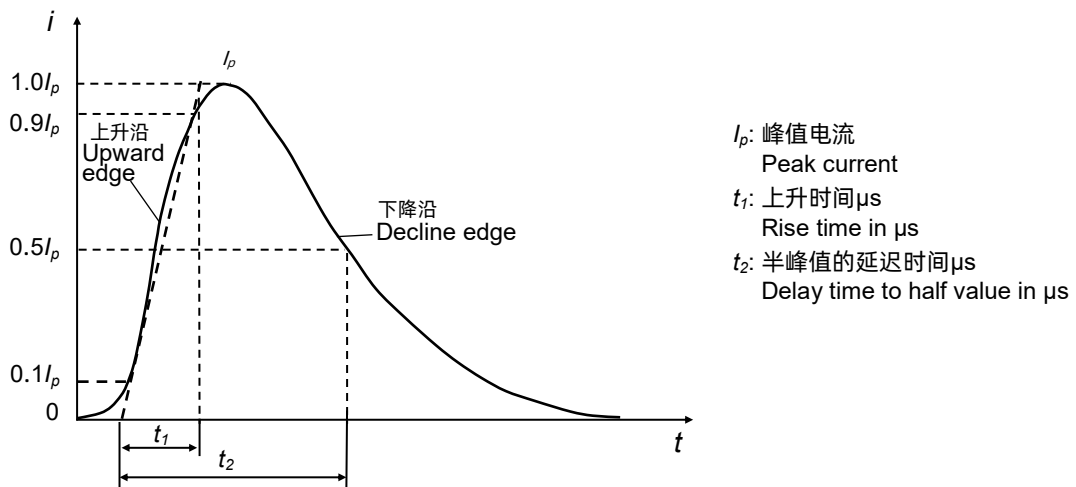

气体放电管

Gas Discharge Tube (GDT)

电气特性 Electrical Characteristics

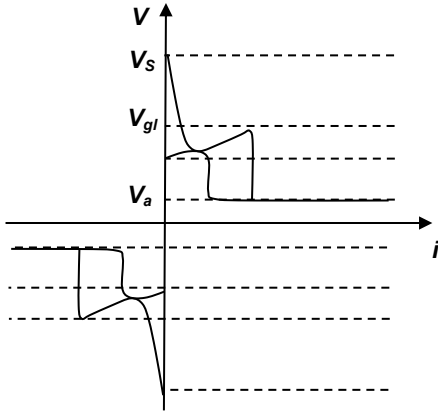

电压和电流之间的关系
Relationship between Current and Voltage

- V_s : 击穿电压 Spark-over Voltage
- V_{gl} : 辉光电压 Glow Voltage
- V_a : 弧光电压 Arc Voltage
- G : 辉光模式 Glow Mode
- A : 弧光模式 Arc Mode

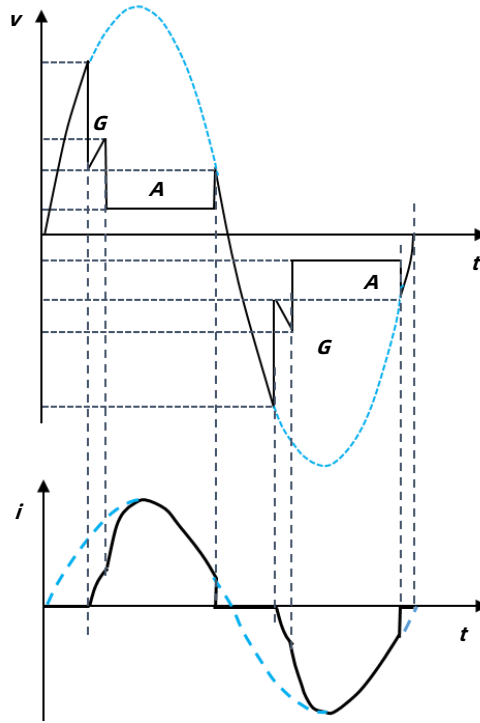

电压和电流的时间变化模式
Time Variation Patterns of Voltage and Current

应用案例 Application Example

AC电源保护 AC Power Protection

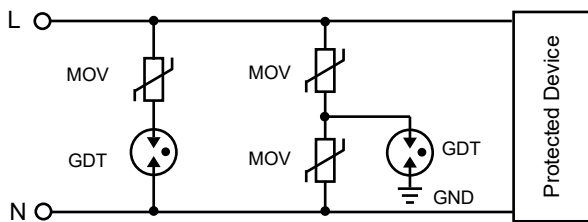

二极管气体放电管信号线路保护 2-Electrod GDT Signal Circuit Protection

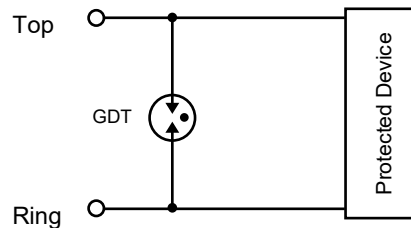

DC电源保护 AC Power Protection

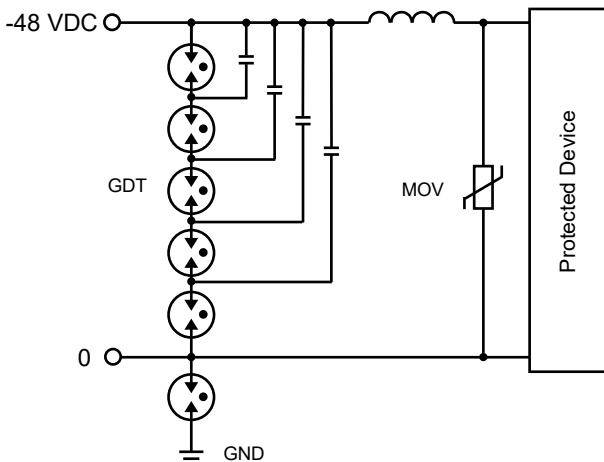

三极管气体放电管信号线路保护 3-Electrod GDT Signal Circuit Protection

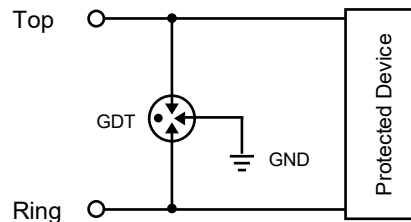

气体放电管

Gas Discharge Tube (GDT)

手工焊接推荐参数 Recommended Hand-soldering Parameters

项目 Items	条件 Condition
烙铁温度 Soldering Iron Temperature	350 °C (Max.)
焊接时间 Soldering Time	4 s (Max.)
焊接点距离产品本体位置 Space between soldering point and product body	2 mm (Min.)

GDT

GDT

波峰焊参数 (参考) Wave Soldering Parameters (For Reference Only)

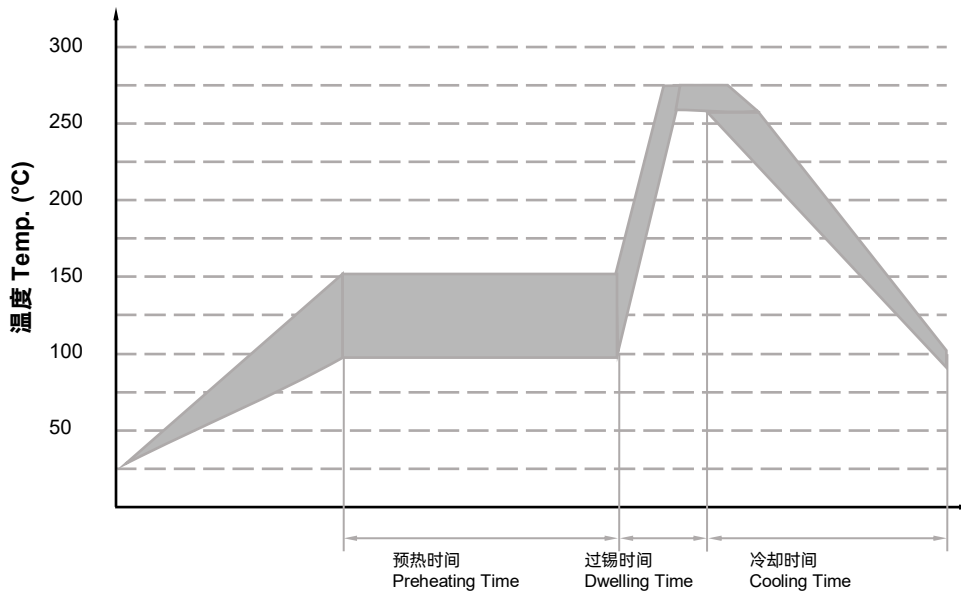

项目 Item	温度 Temp. (°C)	时间 Time (s)
预热 Preheating	90 to 150	< 150
过锡 Dwelling	255 to 280	3 to 10

气体放电管

Gas Discharge Tube (GDT)

回流焊参数（参考） Reflow Soldering Parameters (For Reference Only)

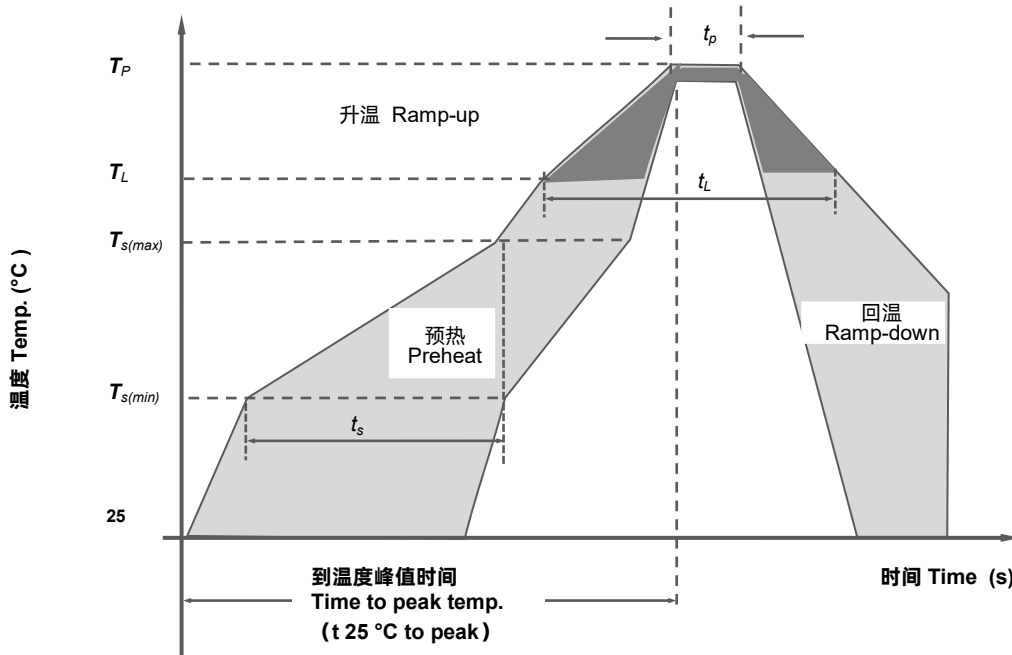

回流焊条件 Reflow Condition		无铅产线 Pb-Free Assembly
预热 Preheat	最低温度 Temp. Min $T_{s(min)}$	150 °C
	最高温度 Temp. Max $T_{s(max)}$	200 °C
	最低温到最高温时间 Time (Min to Max) t_s	(60 to 180) seconds
平均温升率 (熔化温度至峰值) Average ramp up rate (Liquidus Temp. (T_L) to peak)		3 °C / second max
预热温区温升率 $T_{s(max)}$ to T_L Ramp-up Rate		5 °C / second max
回流焊 Reflow	熔化温度 Temp. (T_L) (Liquidus)	217 °C
	熔化时间 Temp. (t_L)	(60 to 150) seconds
最高温度 Peak Temp. (T_P)		(255 to 260) °C
最高温度的维持时间 Time within 5 °C of actual peak Temp. (t_p)		(10 to 30) seconds
回温速率 Ramp-down Rate		6 °C / second max
从25 °C到最高温度时间 Time 25 °C to peak Temp. (T_P)		8 minutes max
不超过 Do not exceed		260 °C

气体放电管

Gas Discharge Tube (GDT)



注意 ATTENTION

使用方法 Usage

1. 在电源线路中最大运行电压超过气体放电管的最小开启电压时，不能使用气体放电管。
Do not operate GDT in power supply networks, whose maximum operation voltage exceeds the minimum spark-overvoltage of the GDT.
2. 气体放电管在长时间电流压力下会变热（起火），这种过载将使连接器失效或器件损坏。
GDT may become hot in the event of longer periods of current stress (burn risk). In the event of overload, the connectors may fail or the component may be destroyed.
3. 如果气体放电管的接触有缺陷，过载的电流能产生火花和大的噪音。
If the contacts of GDT are defective, current load can cause sparks and loud noises.
4. 气压在55 kPa 到106 kPa，对应海拔为+5000 m到- 500 m。
When air pressure is from 55 kPa to 106 kPa. The relative altitude shall be +5000 m to -500 m.

更换 Replacement

气体放电管是不可返修的产品，安全起见，建议采用同类型产品进行更换。
GDT is a non-repairable product. For safety sake, please use equivalent GDT for replacement.

存贮 Storage

包装好的气体放电管应置于干燥、通风和无腐蚀的环境中。
The packaged GDT should be placed in a dry, ventilated and non-corrosive environment.

安装位置 Installation Position

不要将气体放电管安装在人体可碰触到的位置。
Do not install the GDT in a touchable position.

机械应力 Mechanical Stress

装配时不要采取敲击等暴力动作，以免产品失效。
Do not take violent action such as knocking when assembling, to avoid product failure.

气体放电管

Gas Discharge Tube (GDT)

SC系列 Series

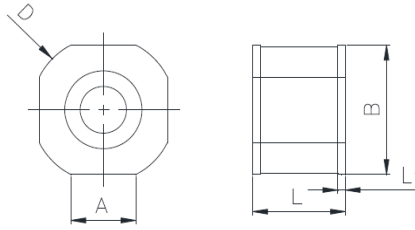

尺寸 Dimensions (mm)

D	B	L
$\Phi 9.3 \pm 0.2$	8.3 ± 0.2	6.0 ± 0.2
L ₁	A	
0.5	4.2	

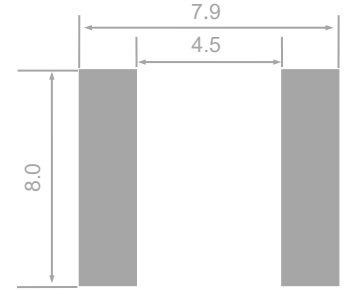

焊盘推荐尺寸
Recommended Pad Size (mm)

技术参数 Specifications

型号 Model	直流击穿电压 D.C. Spark-over Voltage @100 V/s	电压范围 Tolerance of V _s	冲击击穿电压 Impulse Spark-over Voltage @1 kV/μs	弧光电压 Arc Voltage @1 A	冲击放电电流 Impulse Discharge Current @8/20 μs	交流放电电流 Alternating Discharge Current @50Hz 1 s	绝缘电阻 Insulation Resistance		电容 Capacitance 0.5 VDC @1 MHz	安规认证 Agency Approvals		
	V _s	V _s	V	V _a	I _n	I	V _{DC}	IR	C	 		
	V	V	V	A	kA	A (r.m.s.)	V	GΩ	(pF)	UL497B	UL1449	TUV
SC075H - SMD	75	57 ~ 93	≤ 650	≈ 8	20	20	25	≥ 1	≤ 1.5	○	N/A	○
SC091H - SMD	90	72 ~ 108	≤ 600	≈ 8	20	20	50	≥ 1	≤ 1.5	○	N/A	○
SC151H - SMD	150	120 ~ 180	≤ 600	≈ 8	20	20	50	≥ 1	≤ 1.5	○	N/A	○
SC201H - SMD	200	160 ~ 240	≤ 700	≈ 10	20	20	100	≥ 1	≤ 1.5	○	N/A	○
SC231H - SMD	230	184 ~ 280	≤ 700	≈ 10	20	20	100	≥ 1	≤ 1.5	○	N/A	○
SC301H - SMD	300	240 ~ 360	≤ 800	≈ 10	20	20	100	≥ 1	≤ 1.5	○	N/A	○
SC421H - SMD	420	366 ~ 504	≤ 1000	≈ 12	20	20	100	≥ 1	≤ 1.5	○	N/A	○
SC601H - SMD	600	480 ~ 720	≤ 1400	≈ 15	20	20	100	≥ 1	≤ 1.5	○	N/A	○
SC801H - SMD	800	640 ~ 960	≤ 1600	≈ 15	20	20	100	≥ 1	≤ 1.5	○	N/A	○

备注 Note:

- 以上参数基于ITU - T K12 & IEC61643.311的标准。The above parameters based on ITU - T K12 & IEC61643.311 standards.
- “●”表示产品已通过认证。Means GDT has gained the certification.
“○”表示产品即将申请认证。Means GDT product is planned to apply for certification.

气体放电管

Gas Discharge Tube (GDT)

包装信息 Packaging Information

1、PC盒包装（插件产品）

PC Box Package (Leaded Type Shaped Lead Devices)

系列 Series	尺寸 Dimensions (mm)			数量 Quantity (PCS)		
	PC盒 Box	内盒 Inner Box	外箱 Carton	PC盒 Box	内盒 Inner Box	外箱 Carton
SE	215 × 205 × 10.5	230 × 210 × 60	440 × 250 × 325	100	500	5000
SF	215 × 205 × 10.5	230 × 210 × 60	440 × 250 × 325	100	500	5000
TB	215 × 205 × 11.5	230 × 210 × 60	440 × 250 × 325	100	500	5000
TR	215 × 205 × 11.5	230 × 210 × 60	440 × 250 × 325	100	500	5000

备注：包装尺寸与数量仅供参考。
Notes: Packaging dimensions and quantity are for reference only.

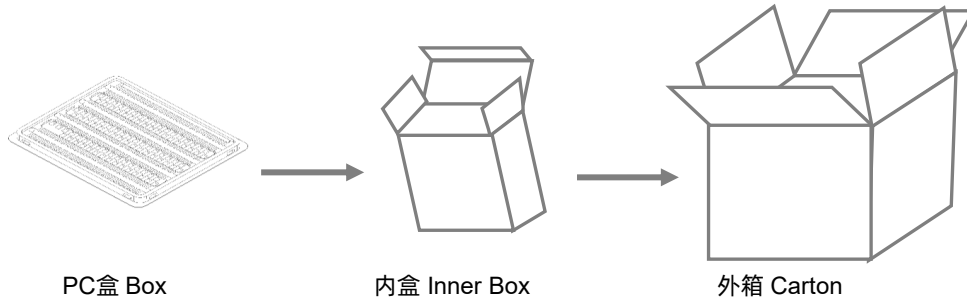

请参考技术规格书的包装信息。Please refer to the specifications for the packaging details.

2、编带包装（插件产品）

Taping Package (Leaded Type Straight Axial Devices)

系列 Series	尺寸 Dimensions (mm)		数量 Quantity (PCS)	
	卷盘 Reel	外箱 Carton	卷盘 Reel	外箱 Carton
SE	Φ340 × 73	360 × 360 × 360	1000	4000
SF	Φ340 × 73	360 × 360 × 360	1250	5000

备注：包装尺寸与数量仅供参考。
Notes: Packaging dimensions and quantity are for reference only.

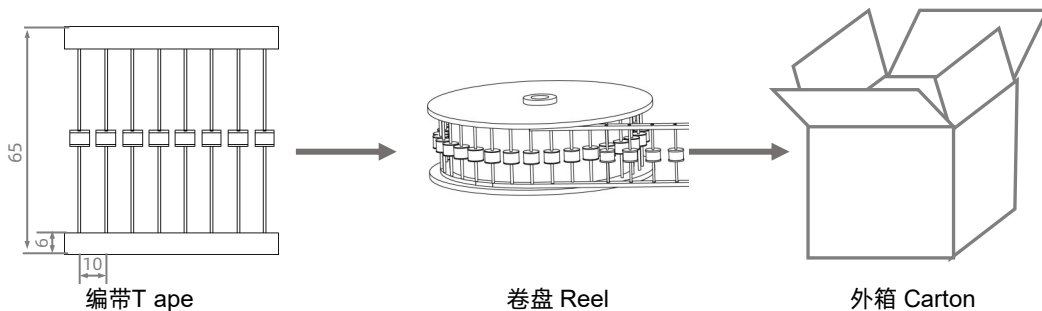

请参考技术规格书的包装信息。Please refer to the specifications for the packaging details.

气体放电管

Gas Discharge Tube (GDT)

3、编带包装 (SMD产品) Taping Package (SMD GDT)

系列 Series	尺寸 Dimensions (mm)			数量 Quantity (PCS)		
	卷盘 Reel	内盒 Inner Box	外箱 Carton	每卷 Reel	内盒 Inner Box	外箱 Carton
SZ	Φ178 × 12.8	200 × 200 × 20	200 × 200 × 180	3000	3000	24000
SW	Φ330 × 12.8	340 × 340 × 40	360 × 360 × 360	2500	5000	40000
SX	Φ330 × 12.8	340 × 340 × 40	360 × 360 × 360	2500	5000	40000
SN	Φ330 × 16.8	340 × 340 × 40	360 × 360 × 360	1000	2000	14000
SD	Φ330 × 16.8	340 × 340 × 40	360 × 360 × 360	1000	2000	14000
SM	Φ330 × 16.8	340 × 340 × 40	360 × 360 × 360	600	1200	8400
SS	Φ330 × 16.8	340 × 340 × 40	360 × 360 × 360	800	1600	11200
SC	Φ330 × 16.8	340 × 340 × 40	360 × 360 × 360	600	1200	48400
TZ	Φ330 × 16.8	340 × 340 × 40	360 × 360 × 360	1000	2000	14000

备注：包装尺寸与数量仅供参考。
Notes: Packaging dimensions and quantity are for reference only.

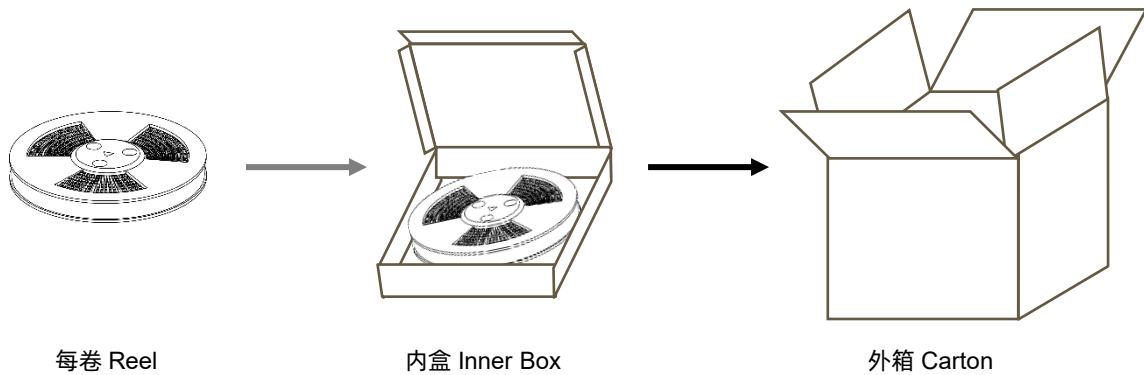

请参考技术规格书的包装信息。 Please refer to the specifications for the packaging details.